

Digital Fiber Amplifier Provides High Performance and Ease of Use

- First amplifier to offer three user-selectable displays: digital level, percentage and analog display
- Flashing LED and digital display of light intensity simplifies optical axis alignment
- Reverse mode sets the digital display to read right-side-up regardless of amplifier orientation
- Adjustable off-delay timer (0 to 200 ms)
- Three setting modes let users choose the ratio of response speed to sensing distance: standard sensing distance (400 mm), long sensing distance (500 mm) and high speed (250 μ s)
- 12-bit A/D converter ensures high resolution for precise detection and differentiation
- Choose digital or dual analog/digital output models with NPN or PNP output



Ordering Information

■ AMPLIFIER UNITS

Item	Appearance	Connections	Output	Part number	
				NPN output	PNP output
Standard models		Pre-lead	ON/OFF output	E3X-DA11	E3X-DA41
Monitor-output models			ON/OFF output Analog output	E3X-DA21	E3X-DA51

Specifications

■ RATINGS/CHARACTERISTICS

Amplifier Unit

Part number		E3X-DA11	E3X-DA41	E3X-DA21	E3X-DA51
		NPN output	PNP output	NPN output	PNP output
Supply voltage		12 to 24 VDC \pm 10%, ripple (p-p) 10% max.			
Current consumption		75 mA max.			
Light source (wavelength)		Red LED (660 nm)			
Required fiber optic cables		All E32 series			
Control output	ON/OFF output	NPN open collector Load current: 50 mA max. Residual voltage: 1 V max.	PNP open collector Load current: 50 mA max. Residual voltage: 2 V max.	NPN open collector Load current: 50 mA max. Residual voltage: 1 V max.	PNP open collector Load current: 50 mA max. Residual voltage: 2 V max.
	Monitor output	-----		Load 1 to 5 VDC, 10 k Ω min. Load resistance 10 k Ω min.	
Operation mode	Switch selectable	Light ON/Dark ON operation			
Circuit protection		Reverse polarity, output short-circuit, mutual interference protection			
Response time		High-speed mode: 250 μ s for operation and reset Standard mode: 1 ms for operation and reset Long-distance mode: 4 ms for operation and reset			
Sensitivity setting		Teaching or manual method			
Timer function		OFF-delay timer, range: 0 to 200 ms (5 ms increment)			
Indicators		7 segment digital incident level display: RED 7 segment digital incident percentage level display: RED 7 segment digital threshold display: RED 2 color indication bar for threshold and excess gain: GREEN and RED Operation indicator: ORANGE			
Display timing	Switch selectable	Normal/peak-hold/bottom-hold			
Display orientation	Switch selectable	Normal/reverse			
Optical axis adjustment		Optical axis adjustment possible (flashing function)			
Ambient illumination		Illumination intensity at light-intercepting surface: Incandescent lamp: 3,000 lx max.; Sunlight: 10,000 lx max.			
Ambient temperature	Operating	-25°C to 55°C (-13°F to 131°F) with no icing or condensation			
	Storage	-30°C to 70 (-22°F to 158°F) with no icing or condensation			
Ambient humidity		Operating and storage: 35% to 85% (with no condensation)			
Insulation resistance		20 M Ω min. (at 500 VDC)			
Dielectric strength		1,000 VAC at 50/60 Hz for 1 minute			
Vibration resistance		10 to 55 Hz with a 1.5-mm double amplitude or 300 m/s ² for 2 hrs each in X, Y and Z axes			
Shock resistance		500 m/s ² : 3 times each in X, Y and Z axes			
Degree of protection		IEC60529 IP50 (when protective cover is attached)			
Connections	Prewired	3 conductor cable, 2 m (6.5ft)		4 conductor cable, 2 m (6.5ft)	
Weight (packed state)		Approx. 100 g			
Material	Case	PBT			
	Cover	Polycarbonate			
Accessories		Mounting bracket, instruction sheet			

Nomenclature

■ DIGITAL FIBER-OPTIC AMPLIFIER

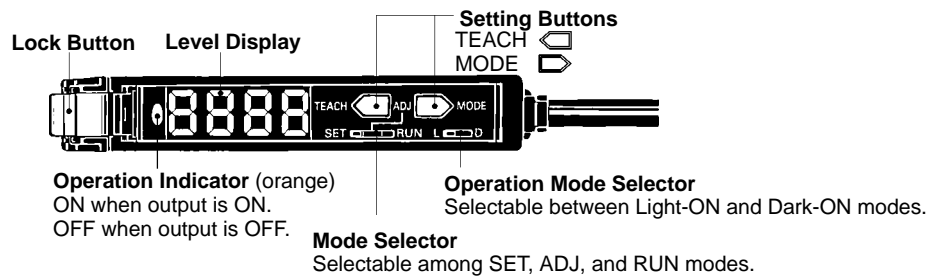

■ DISPLAY AND SPECIAL FUNCTION SETTINGS

Display Setting

The E3X-DA offers three display modes, which are Digital Incident Level display, Digital Percent display and Analog display.

- **Digital Incident Level Display**: the incident level is digitally displayed.
- **Digital Percent Display**: the threshold-based excess gain is displayed in percentage.
- **Analog Display**: threshold and excess gain is displayed by two-color (red and green) bar graph.

Special Function Setting

The E3X-DA series has various functions that give users more flexibility in meeting a variety of application requirements.

- **Sensing Function**: Enables users to choose either standard sensing distance mode (400 mm), long sensing distance mode (500 mm) or high speed mode (response time = 250 μ s)
- **Timer Function**: Enables users to select various OFF-delay timer settings from (0 to 200 ms). OFF-delay timer lengthens the duration of a short, high-speed signal so that it can be recognized as input to Programmable Controllers during a scan cycle.
- **Flashing Function**: Flashing red LED allows easier optical axis adjustment.
- **Display Hold Setting**: This function provides easy data reading during optical axis adjustment and high-speed detection by holding the displayed value for a period of time. Displayed data gets updated every 2 seconds. Within the 2-second timeframe, the maximum or minimum value is displayed (data will be flashing).
- **Display Orientation Setting**: Reversible digital display provides easy data reading from any mounting orientation.

Operation

OUTPUT CIRCUITS

Output	Part number	Mode selector	State of output transistor	Output circuit	Timing chart
NPN	E3X-DA11	LIGHT ON (L/ON)	Light ON		
		DARK ON (D/ON)	Dark ON		
	E3X-DA21	LIGHT ON (L/ON)	Light ON	<p>*Load resistance: 10 kΩ min.</p>	
		DARK ON (D/ON)	Dark ON		
PNP	E3X-DA41	LIGHT ON (L/ON)	Light ON		
		DARK ON (D/ON)	Dark ON		

Output	Part number	Mode selector	State of output transistor	Output circuit	Timing chart
PNP	E3X-DA51	LIGHT ON (L/ON)	Light ON	<p>*Load resistance: 10 kΩ min.</p>	
		DARK ON (D/ON)	Dark ON		

■ CHOOSING THE RIGHT TEACHING METHOD

Refer to the following to select the most suitable sensitivity setting method.

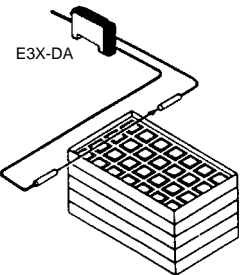
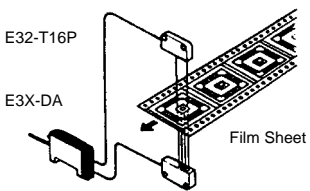
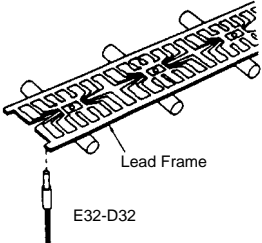
Sensitivity Setting	<p>Using the Sensor at the Maximum Sensitivity</p> <p>Application Examples</p> <ul style="list-style-type: none"> • Detection of a large passing object with through-beam fibers • Sensing applications with no background <p>Checking IO Tray Arrangements</p> 	<p>Sensing Slight Differences</p> <p>Application Examples</p> <ul style="list-style-type: none"> • Detection of transparent objects • Color discrimination • Detection of delicate level difference <p>Detecting IC Chips on Film Sheet</p> 	<p>Sensitivity Setting Without Objects</p> <p>Application Examples</p> <ul style="list-style-type: none"> • Detection of minute passing objects • Detection of lead wires • High-precision positioning <p>Detecting Lead Frame Position</p> 
	<p>Maximum Sensitivity Setting</p>	<p>Two-point Teach Mode</p>	<p>One-point Teach Mode</p>

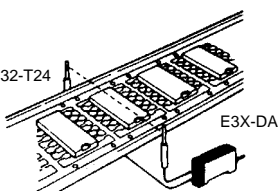
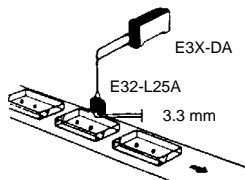

Sensitivity Adjustment (Fine-tuning)	<p>Fine-tuning on Production Lines</p> <p>Reason</p> <ul style="list-style-type: none"> • Marginal sensitivity adjustments is required considering the differences in targets • For high-precision positioning of electronic parts
	<div style="display: flex; justify-content: space-around;"> <div style="width: 45%;"> <p>Detecting Lead Frame Rises</p>  </div> <div style="width: 45%;"> <p>Detecting Cassette Tape Cases</p> <p>Ensuring reliable detection without being influenced by the difference in color or mark.</p>  </div> </div>
	<p>One-point Teach Mode (Positioning)</p>

■ SENSITIVITY SETTING (TEACHING)

Set the mode selector to "SET" to start teaching. The red level display will flash if teaching error occurs. In this case, repeat the entire teaching procedure. The E3X-DA has the following four teaching modes.

Maximum Sensitivity Setting

1. Set the mode selector to "SET".

SET 

2. Press the "TEACH" button for 3 seconds (min).

TEACH 

3. Teaching is complete when the level display changes from red to green. Digital incident level will appear shortly after the display changes from red to green.

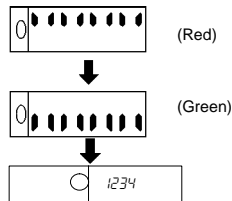

4. Set to "RUN" mode.

 RUN

■ ONE-POINT TEACH MODE (WITHOUT OBJECT)

1. Set the mode selector to "SET".

SET 

2. Press the "TEACH" button for approximately 1 second.

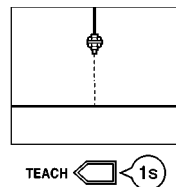

3. Teaching is complete when the red level display is lit. Digital incident level will appear shortly after the red level display is lit.

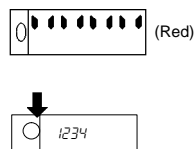

4. Set to "RUN" mode.

 RUN

5. The threshold is automatically set.

Note: Try the two-point teaching mode if the difference in level is too fine.

■ TWO-POINT TEACH MODE

1. Set the mode selector to "SET".

SET 

2. Press the "TEACH" button for approximately 1 second when the object is at the sensing position.

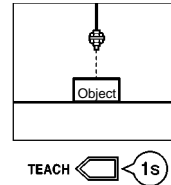

3. The red level display is lit.



4. Remove the object from the sensing area, and press the "TEACH" button for approximately 1 second.

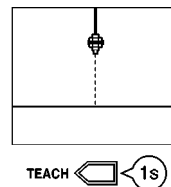

5. Teaching is complete when the green level display is lit. Digital incident level will appear shortly after the green display is lit.

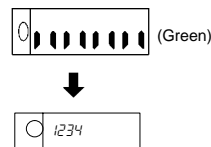

6. Set to "RUN" mode.

 RUN

■ ONE-POINT TEACH MODE (POSITIONING)

1. First set to "One-point Teach Mode (without object)".
2. Set the sensor to "ADJ" mode.



3. While in the "ADJ" mode, adjust the threshold by pressing the "TEACH" button until the operation indicator is lit. Pressing the "TEACH" button increases the sensitivity, but lowers the threshold level. Pressing the "MODE" button decreases the sensitivity, but increases the threshold level.

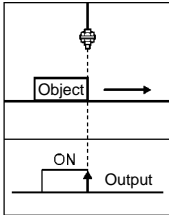

4. Set to "RUN" mode.



■ DISPLAY SETTING

E3X-DA can be programmed to display digital incident level, digital percent level or analog display.

1. Set the mode selector to "RUN". Digital incident level should appear in the display.

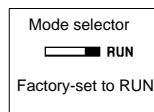

2. Press the "MODE" button until "123P" is displayed. Digital percent level is now displayed.

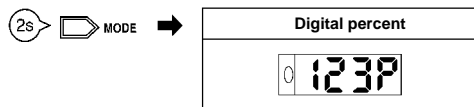

3. Press the "MODE" button to activate the "Analog Incident Level" display. Two color (red and green) bar graph should appear in the display.

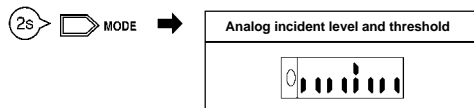

4. Press the "MODE" button to return to the "Digital Incident Level" display.



■ SPECIAL FUNCTION SETTING

E3X-DA series has various functions that give users more flexibility in solving a variety of application requirements such as the following:

- Long sensing distance (Sensing Function)
- Faster response time (Sensing Function)
- Off-delay timer (Timer Function)
- Optical axis alignment (Flashing Function)
- Digital data display hold setting (Display Hold Setting)
- Data display orientation (Display Orientation Setting)

Sensing Function

1. Set the mode selector to "SET".



2. Press the "MODE" button until "F 5t" is displayed. The "Standard" sensing function (F 5t) is the default setting. The "Standard" sensing function provides the standard detecting distance (400 mm). Response time is 1 ms.

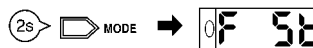

3. Press the "TEACH" button to obtain the "Long Distance" sensing function. "F Ld" should appear on the display. The "Long Distance" function provides a sensing distance that is about 1.3 times that of the "Standard" detecting distance (diffuse fiber in use). The "Long Distance" setting has a response time of 4 ms.



4. Press the "TEACH" button to obtain the "High Speed" sensing function. "F HS" should appear on the display. The "High Speed" function provides a detection distance that is about one-third of the standard distance (diffuse fiber in use). Response time is 0.25 ms.

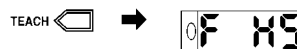

5. Press the "TEACH" button to return to the "Standard" sensing function display.



Timer Function

1. Set the mode selection to "SET".

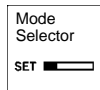

2. Press the "MODE" button until "t_0" is displayed. "t_0" is the default setting.

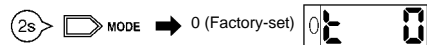

3. Press the "TEACH" button to set to the desired time setting (5 ms increment).

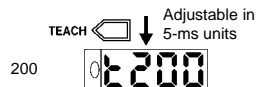

Flashing Function

1. Set the mode selector to "SET".

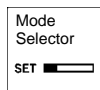

2. Press the "MODE" button until "LOFF" is displayed. "LOFF" is the default setting.



3. Press the "TEACH" button to activate the "flashing" function. Display should read "L On".



4. Press the "TEACH" button to return to the "LOFF" mode.



Display Hold Setting Function

1. Set the mode to "SET".

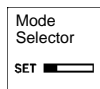

2. Press the "MODE" button until "HOFF" is displayed. "HOFF" is the default setting.



3. Press the "TEACH" button to activate "Peak Hold" display. Displayed data get updated every 2 seconds. The maximum value is displayed.

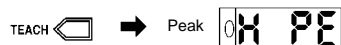

4. Press the "TEACH" button to activate "Bottom Hold" display. Displayed data gets updated every 2 seconds. The minimum value is displayed.



5. Press the "TEACH" button to return to the default setting, "HOFF".

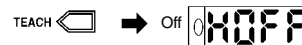

Display Orientation Setting Function

1. Set the mode selector to "SET".



2. Press the "MODE" button until "d123" is displayed. "d123" is the standard setting.



3. Press the "TEACH" button to change the orientation of the display. "d321" should now appear in the display.



4. Press the "TEACH" button to return to the standard setting, "d123".



Dimensions

Unit: mm (inch)

AMPLIFIER

E3X-DA□1

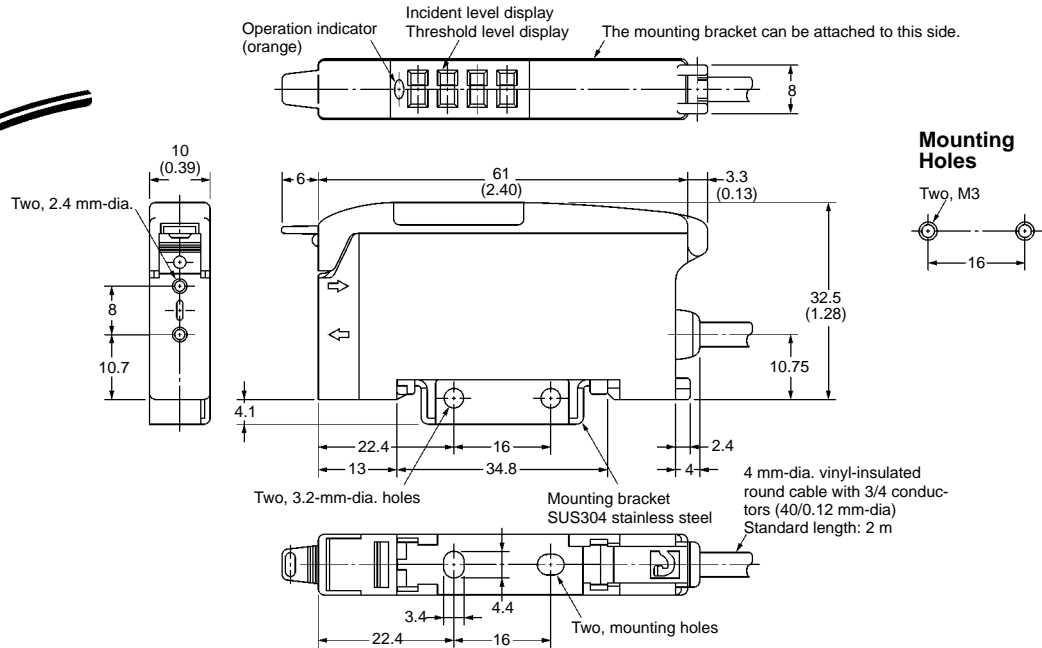
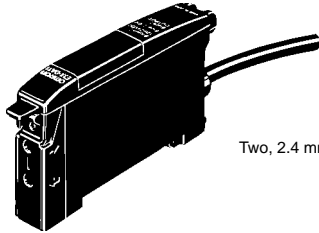

Installation

CONNECTION

Connection with S3D2 Sensor Controller

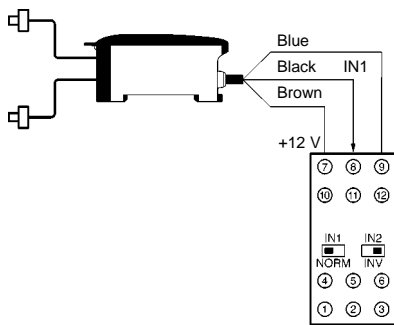

Note: A maximum of two Sensors can be connected.

Power supply voltage	Output	Functions	Part number
100 to 240 VAC	Relay	AND, OR	S3D2-AK
		AND, OR, and timer	S3D2-CK
		Flip-flop	S3D2-BK
	Transistor	AND, OR, and timer	S3D2-CC
	Relay	2 inputs, 2 outputs,	S3D2-DK
		2 inputs, 2 outputs, and timer	S3D2-EK
24 VDC	Relay	AND, OR	S3D2-AKD
	Relay	AND, OR, and timer	S3D2-CKD

Connection with K3NX-VD2□ Process Meter

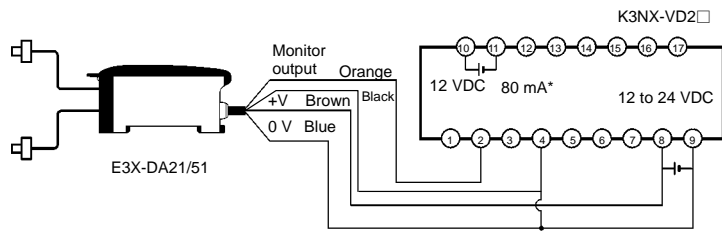

* Use this service power supply for the Sensor with reference to the power consumption of each Sensor.

- Note:
1. Various I/O Units are available for the K3NX. Select an appropriate output type depending on the application.
 2. For details about the K3NX, refer to the *K3NX Data Sheet* in Omron's *Digital Panel Meters* catalog.
 3. This wiring is for the K3NX with DC power supply specifications and the Monitor (Analog) Sensor with DC power supply specifications. Check respective power supply specifications before wiring them.

■ MOUNTING

Mounting

1. Mount the front part on the mounting bracket (sold together) or on a DIN rail. (See below.)
2. Press the back part onto the mounting bracket or onto the DIN rail.

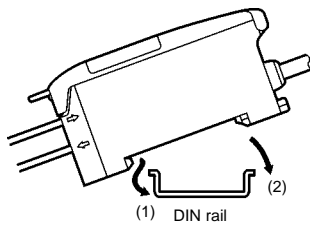

Removal

By pulling back the lock (yellow) on the bottom with a flat blade screwdriver, the amplifier can be removed easily.

In the case of side mounting, attach the mounting bracket on the amplifier first, and secure the amplifier with M3 screws and washers. The diameter of the washers should be no more than 6 mm.

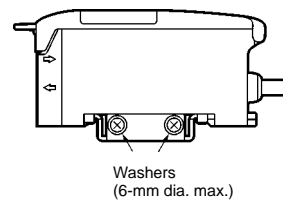

■ FIBER UNIT

Mounting

Tightening Force

The tightening force applied to the sensing head should be as follows:

Threaded Model

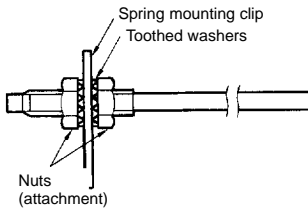

Unthreaded Model

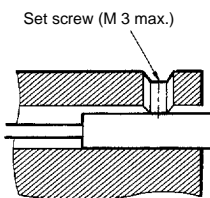

Sensing head	Tightening torque
M3/M4 screw	0.78 N • m max.
M6 screw/ 6-mm dia. column	0.98 N • m max.
1.5-mm dia. column	0.2 N • m max.
2-mm dia./3-mm dia. column	0.29 N • m max.
E32-T12F 5-mm dia. Teflon model	0.78 N • m max.
E32-D12F 6-mm dia. Teflon model	
E32-T16	0.49 N • m max.
E32-R21	0.59 N • m max.
E32-M21	Up to 5 mm to the tip: 0.49 N • m max. More than 5 mm from the tip: 0.78 N • m max.
E32-L25A	0.78 N • m max.
E32-T16P E32-T24S E32-L24L E32-L25L	0.29 N • m max.

Use a proper-sized wrench.

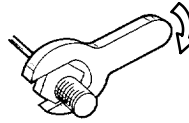

Fiber Connection and Disconnection

The E3X amplifier has a lock button. Connect or disconnect the fibers to or from the E3X amplifier using the following procedures:

1. Connection

Remove the protective cover, insert the fiber into the amplifier, and lower the lock button until a click is heard.

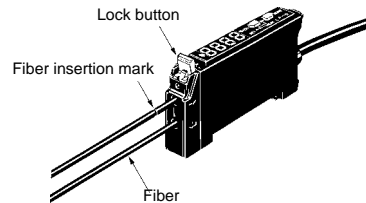

After cutting the fiber using the E39-F4 Fiber Cutter, put an insertion mark on the fiber as a guide for correct insertion into the amplifier, and then insert the fiber up to this mark.

2. Disconnection

Remove the protective cover and raise the lock button to pull out the fiber.

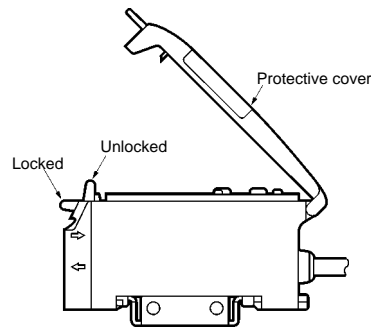

Note: Remove the protective cover and raise the lock lever to pull out the fiber. (Before removing the fiber, be sure to confirm that the lock is released so as to maintain the fiber properties.)

3. Precautions for Fiber Connection/Disconnection

Be sure to lock or unlock the lock button within an ambient temperature range between -10°C and 40°C .

■ FIBER INSERTION

Make sure that the fiber is fully inserted in the amplifier. The sensing distance may decrease if the fiber is not fully inserted.

2.2-mm dia. Fiber

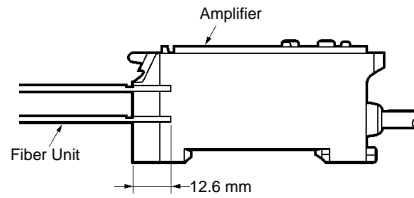

Thin Fiber with the E39-F9 Attachment

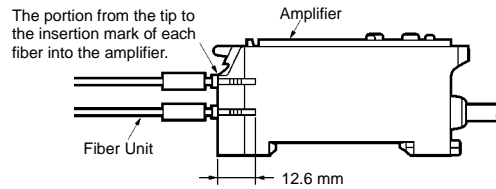

Fiber with Fixed Length

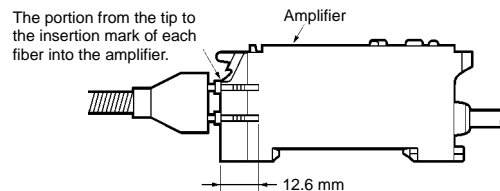

Insert the fiber into the amplifier up to the insertion mark. Proper fiber performance will not be achieved unless the fiber is inserted all the way to the insertion mark. (This method is applicable to standard, 2.2-mm-dia. fibers only.)

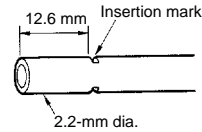

The cutting holes cannot be used twice. If the same hole is used twice, the cutting face of the fiber will be rough and the sensing distance will be reduced. Always use a new hole.

Use either one of the two holes on the right (refer to the following figure) to cut a thin fiber as follows:

1. An attachment is temporarily fitted to a thin fiber before shipment.

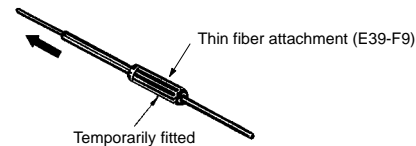

2. Secure the attachment after adjusting the position of the thin fiber in the direction indicated by the arrow.



3. Insert the fiber to be cut into the E39-F4.

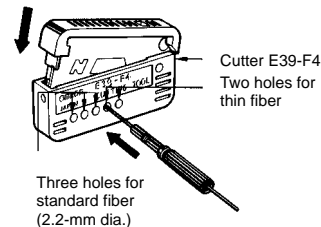

4. Finished state (proper cutting state)

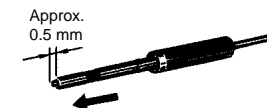

Note: Insert the fiber in the direction indicated by the arrow.

■ CUTTING FIBER

Insert a fiber into the Fiber Cutter and determine the length of the fiber to be cut.

Press down the Fiber Cutter in a single stroke to cut the fiber.

An insertion mark can be placed on the fiber to serve as a reference when inserting the fiber into the amplifier. Use the following procedure.

Confirm through the cutter hole that the fiber is inserted beyond the insertion mark hole so that the insertion mark is properly indicated, and then press firmly down on the cutter.

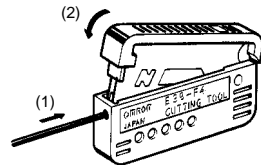

Connection

Do not pull or press the fiber units. The fiber units have a withstand force of 9.8 N or 29.4 N (pay utmost attention because the fibers are thin).

Do not bend the fiber unit beyond the permissible bending radius.

Do not bend the edge of the fiber units (excluding the E32-T□R and E32-D□R).

Correct

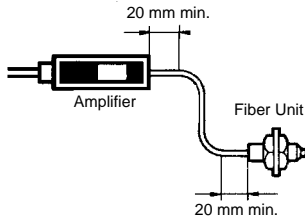

Incorrect

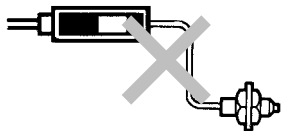

Note: Do not apply excess force on Fiber units.

Correct

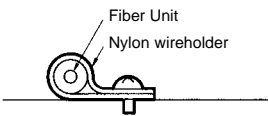

Incorrect

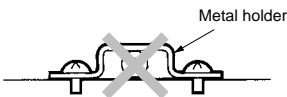

Excessive vibration can break the fiber head. Use the following method to prevent fiber head breakage.

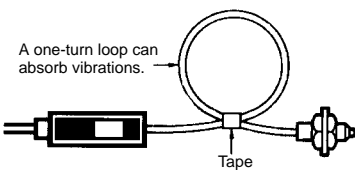

Bending Radius

E39-F11 Sleeve Bender

The bending radius of the stainless steel tube should be as large as possible. The smaller the bending radius becomes, the shorter the sensing distance will be.

Insert the tip of the stainless steel tube to the Sleeve Bender and bend the stainless steel tube slowly along the curve of the Sleeve Bender (refer to the figure).

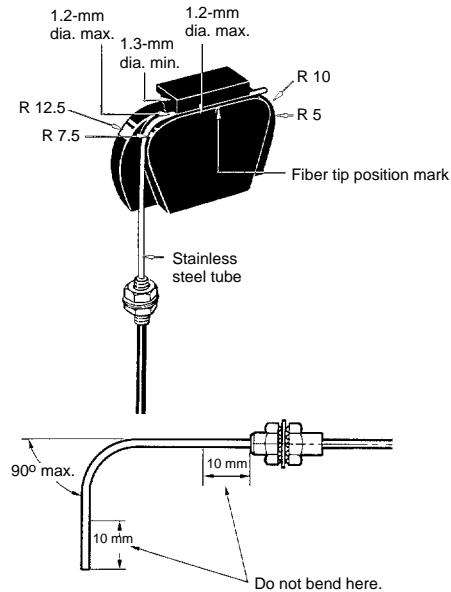

E39-F32□ Protective Spiral Tubes

Insert a fiber to the protective spiral tube from the head connector side (screwed) of the tube.

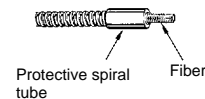

Push the fiber into the protective spiral tube. The tube should be straight so that the fiber is not twisted when inserted. Then turn the end cap of the spiral tube.

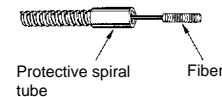

Secure the protective spiral tube on a suitable place with the attached nut.

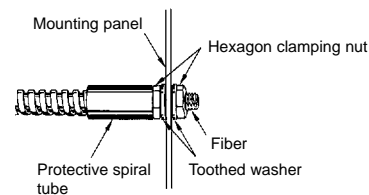

Use the attached saddle to secure the end cap of the protective spiral tube. To secure the protective spiral tube at a position other than the end cap, apply tape to the tube so that the portion becomes thicker in diameter.

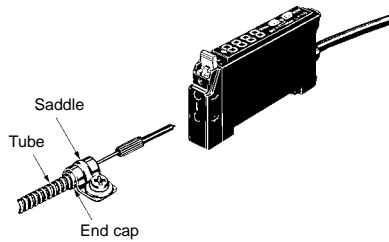

E39-F10 Fiber Connector

Mount the fiber connector as shown in the following illustrations

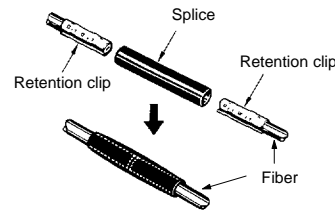

Each fiber unit should be as close as possible before they are connected.

Sensing distance will be reduced by approximately 25% when fibers are connected.

Only 2.2-mm-dia. fibers can be connected.

Precautions

■ AVOID DAMAGE TO THE E3X-DA

- Voltage must not exceed the rated voltage of the E3X-DA.
- When supplying power to the E3X-DA, make sure that the polarity of the power is correct.
- Do not short-circuit the load connected to the E3X-DA.
- Do not impose 100 VAC or more on models that operate with DC.
- Do not use the E3X-DA in environments where flammable or explosive gas exists.
- Do not disassemble, repair or modify the E3X-DA.
- The E3X-DA has an enclosure rating of IP50; do not immerse in water.
- Load must be connected to the E3X-DA.

■ INSTALLATION

Power Reset Time

- The E3X-DA is ready to sense objects 100 ms after the unit is turned on.
- If power is supplied to the E3X-DA and the load independently, make sure to turn ON the E3X-DA first.
- When the E3X-DA is turned ON or OFF, the operation indicator will be illuminated for an instant, but no control output will be turned ON.

Power Supply

- Do not connect the E3X-DA to a full-wave or half-wave rectified power supply.
- When a standard switching power supply is used, the frame ground (FG) and the ground (G) terminal must be grounded. Otherwise, the E3X-DA may experience noise problem.

■ WIRING

Cable

- The cable can be extended up to 100 m provided the wire thickness is at least 0.3 mm².
- Do not pull cables with pulling force exceeding 50N.

Avoid Damage or Malfunction Due to Induction Noise

- Never run the E3X-DA cables in the same conduit with power lines or high tension cables.

Mutual Interference Protection Function

- Perform two-point teaching if two or three fiber units are closely mounted. Only apply power to the unit that is in teaching operation or block the emitters of the fiber units that are not in teaching mode.

■ FURTHER INFORMATION

Correcting an EEPROM Error

- An EEPROM error may result if power failure or static noise occurs. In this case, repeat the whole teaching procedure.

NOTE: DIMENSIONS SHOWN ARE IN MILLIMETERS. To convert millimeters to inches divide by 25.4.

OMRON[®]
OMRON ELECTRONICS, INC.
One East Commerce Drive
Schaumburg, IL 60173
1-800-55-OMRON

OMRON CANADA, INC.
885 Milner Avenue
Scarborough, Ontario M1B 5V8
416-286-6465